

HOME STYLE PATTERN BOOK

MODERN

Contemporary Selections from the Andersen Style Library

HOME STYLE PATTERN BOOK

MODERN

Contemporary Selections from the Andersen Style Library

Modern Home Style Overview..... 4

International

Home Style Overview..... 6

Colors & Finishes..... 8

Primary Windows & Groupings..... 9

Sash Design..... 10

Door Proportions..... 11

Window & Door Hardware..... 12

Interior Trim Style Elements 14

Product Index..... 15

Miesian

Home Style Overview..... 16

Colors & Finishes..... 18

Groupings..... 19

Sash Design..... 20

Door Proportions..... 21

Window & Door Hardware..... 22

Interior Trim Style Elements 24

Product Index..... 25

Industrial

Home Style Overview..... 26

Colors & Finishes..... 28

Window Groupings 29

Sash Design..... 30

Door Proportions..... 31

Window & Door Hardware..... 32

Interior Trim Style Elements 34

Product Index..... 35

ARCHITECTURAL AUTHENTICITY MADE EASY

Achieve authentic architectural style with A-Series products that were developed in conjunction with leading architects. These windows and doors feature a unique system of options that work seamlessly together, allowing you to produce virtually any style with ease.

E-Series windows and doors are made to your exact specifications and give you unmatched design freedom within the architectural style you've chosen. They allow you to create dramatic shapes and sizes, and feature 50 standard colors, custom colors, plus a wide range of interior wood species.

Andersen offers you the tools and products that make it easier to design and build today's most popular, time-proven architectural styles.



Craftsman Bungalow



International Modern



Tudor

ANDERSEN HOME STYLE PATTERN BOOKS

Since ancient Roman times, architects have relied on the use of pattern books to outline the principles and formulas of architectural styles.

These early documents recorded the building patterns that were deemed to be best, and were important tools for architects of the day in their communication with other architects, as well as builders, clients, rulers and politicians.

Today, there is a renewed interest in pattern books as planners and developers look to build new communities by learning from the successes of the past. Andersen is committed to making this type of great architectural design more attainable through our products, tools and services.

The result of years of research, pattern books from the Andersen Style Library present the quintessential architectural details of the most popular American home styles, with an emphasis on window and door design options. With these books, Andersen makes it easier for architects, builders and homeowners to communicate with a common language, and to confidently design, build and live in a home of distinction.

For more information on the Andersen Style Library, visit andersenwindows.com/stylelibrary.



Georgian/Federal

Spanish Colonial Revival

American Farmhouse

MODERN RESIDENTIAL ARCHITECTURE

Identifying architectural styles is traditionally accomplished by looking back in time to see what style movements have emerged over the years. Since the Modern style is ever evolving to reflect modern thought and sensibilities, there isn't always a consensus as to what constitutes this movement. That said, three approaches have risen to the top in current Modern style architecture: International Modern style, Miesian Modern style and Industrial Modern style.

The roots of Modernism are generally attributed to a small number of architects working in Europe between World Wars I and II. Leaving everything that was traditional behind, their work explored the use of modern materials and current-day engineering practices rather than relying on historic procedures or precedent. While the Bauhaus in Germany was the center of modern design in the 1920s, many of its faculty and students fled Germany during World War II to continue their work in the United States.

In the Modernist style, a building's sole purpose is to serve the functional needs of its inhabitants, leading to the thought that a home should be a "machine for the living." As such, its focus is on interior function while the exteriors are usually stark and unadorned.

With their emphasis on function, Modernist style architects viewed windows simply as a means of bringing in fresh air and daylight – much in the same way they were viewed in factories. To carry the utilitarian look of the factory windows into their residential designs, operating windows were either awning or casement units. Trim was either extremely simple or eliminated altogether.

While Modernism originally began as more of a social philosophy than a definitive style, its impact on architecture is as impressive as the homes it has helped create.



International Modern Style Home

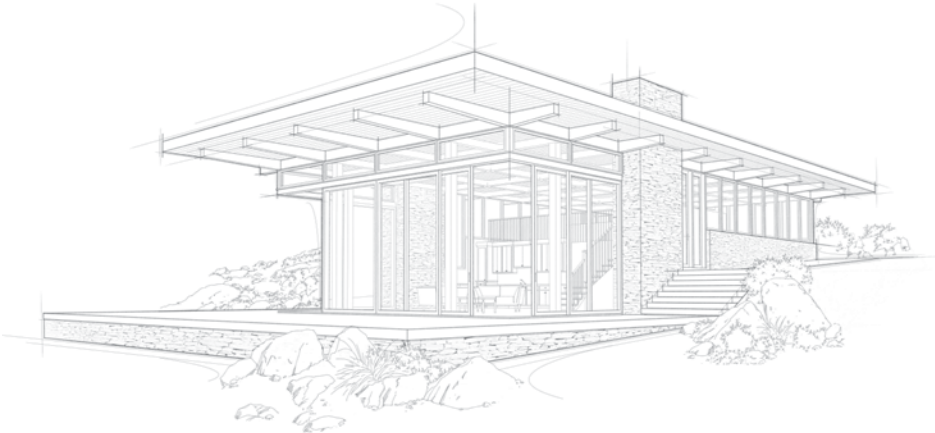

Miesian Modern Style Home



Industrial Modern Style Home

THE INTERNATIONAL MODERN HOME



Swiss/French architect Charles-Édouard Jeanneret-Gris, who is better known as Le Corbusier, is most closely associated with what is now known as the International Modern style.

However, Le Corbusier did not coin the name “International Style”. It was first used by architectural historian Henry-Russell Hitchcock and architect Philip Johnson in the 1936 book of the same name. Le Corbusier actually referred to the private homes he designed as machines a habiter or “machines for living”. The term comes from

his belief that function needed to be of primary importance since it had the ability to improve the inhabitants’ lives. As a result, exteriors of homes in the International Modern style were stripped of ornamentation and instead feature precise, machine-like forms devoid of historical references.

Le Corbusier’s Villa Savoye, located in France, is considered by many to be one of the world’s best examples of this style.



ESSENTIAL STYLE ELEMENTS

- Windows featuring narrow frame profiles to make the frame disappear as much as possible
- Predominantly large windows arranged in groupings to form rectangles or squares, sometimes extending from floor to ceiling or wrapping around corners
- Recessed windows that create negative space, which contrasts with the positive space of the walls
- Sculptural and asymmetrical arrangement of intersecting block forms with a flat roof



EXTERIOR COLOR PALETTE

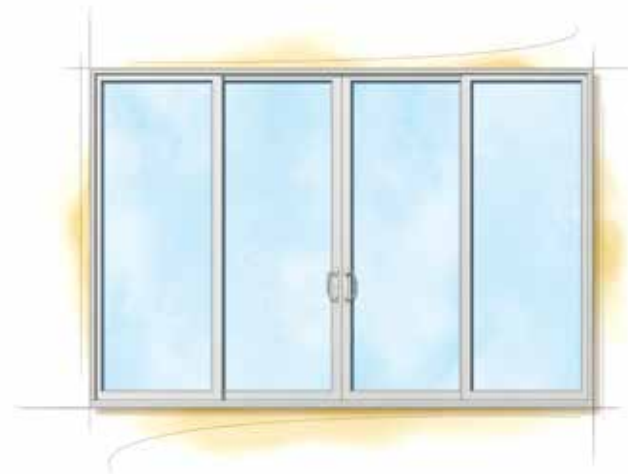

COLORS & FINISHES

While the exteriors of International Modern style homes may feature a range of painted colors, the most common color is white. On the interior, when a painted finish is used, it is most frequently white.

WINDOW/DOOR EXTERIOR

Color Palette



Colony
White

Dark Ash



Smokey
Gray

Balsa
White



Clear
Anodized

Copper
Anodized



Olive

Black



Exterior

WINDOW/DOOR INTERIOR

Wood Species



Walnut

Mahogany*



Cherry

Maple

Stain Colors



Russet

Clear Coat

Painted

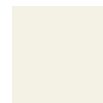

White



Interior

*Actual wood species is either Sapele or Sipo, both non-endangered species grown in Africa, with color and characteristics similar to Central American mahogonies. Printing limitations prevent exact color duplication. Please see your Andersen supplier for actual color samples.

PRIMARY WINDOWS & GROUPINGS

In International Modern style homes, expanses of glass are designed to contrast with expanses of undecorated walls. To achieve this, rectangular units are arranged in various ways to create one larger rectangular grouping. These groupings often stretch nearly the entire height of a wall, the width of a room, or both.

The windows used to create these larger rectangular groupings may be operable, stationary or a combination. For operable units, casement windows are ideal because they offer uninterrupted glass. They may be the currently popular style that operates with the use of a crank handle or a push out version that reflects Modernism's early 20th-century European roots.

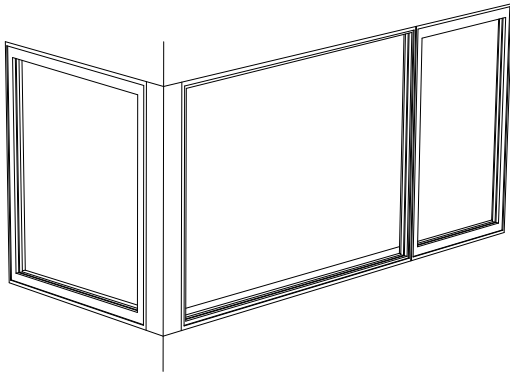

Fixed and casement windows joining at a typical vertical mullion and a corner mullion.

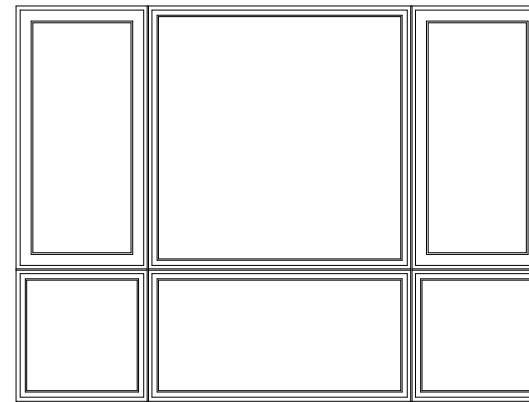

Rectangular arrangement of fixed windows without sash and operable windows with sash.

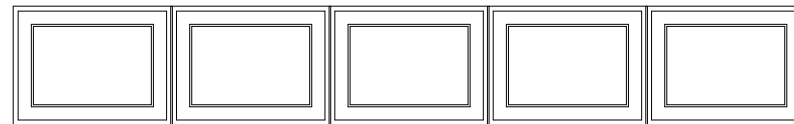

Rectangular arrangement of transom windows with sash.

SASH DESIGN

The windows in International Modern style homes try to emphasize the glass area while the frames and sash are made to disappear as much as possible.

For this reason, stationary windows are quite common. Often, the sash is eliminated entirely and the glass is placed directly into the frame, rather than into a sash that is installed into a frame. Operable units simply have the sash added, making it easy to differentiate between operating and stationary windows. If a more uniform appearance is desired, stationary windows may also include a sash.

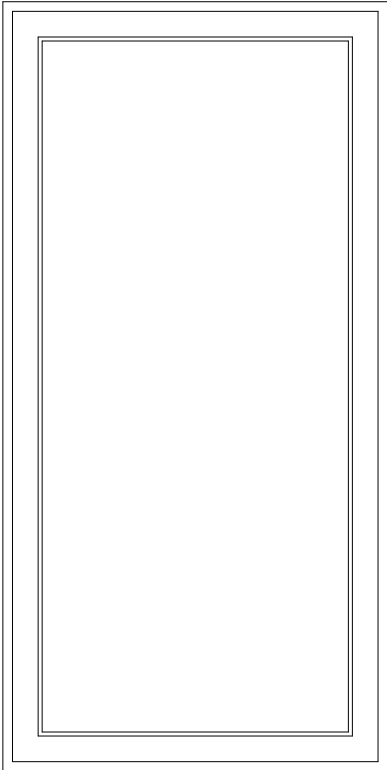
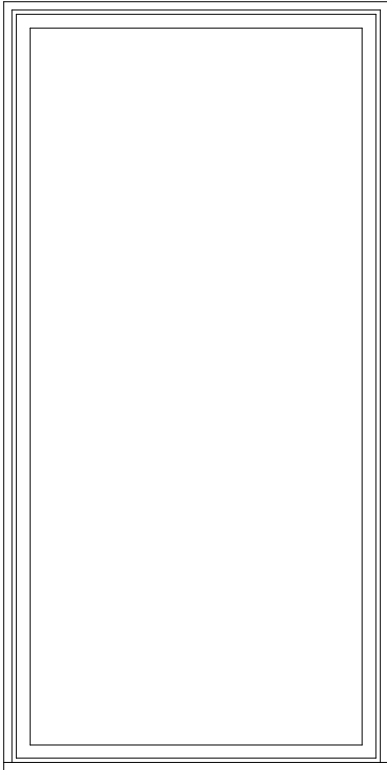
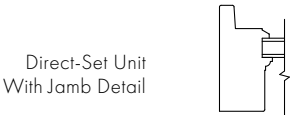

DOOR PROPORTIONS

Main entrance doors in International Modern style homes are frequently single doors. While standard proportions can be found, taller doors are more common.

Auxiliary doors are used at utility entrances and locations such as terraces and patios. Auxiliary doors that are not on a prominent face of the house are usually single doors of a standard size, whereas auxiliary doors leading to a terrace or patio would commonly be multiple doors in one unit. In these instances, the proportion of the entire door unit is both a function of the individual door size and the number of doors within that unit, as is illustrated here.

Typical proportion ratios – Main doors

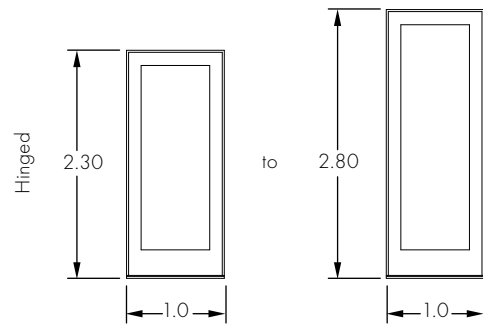

Typical proportion ratios – Auxiliary doors

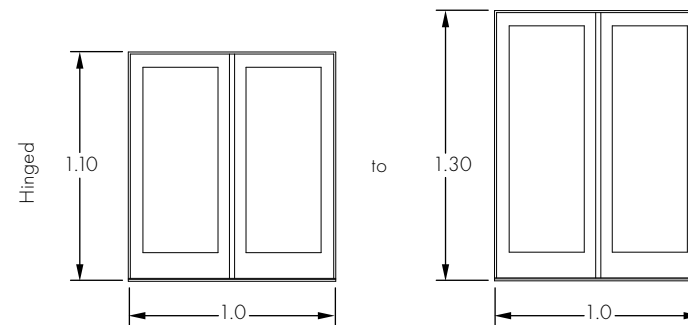

Andersen Authenticity

To help make your vision a reality, Andersen® doors are available in custom sizes and may be ordered to the exact specifications your Modernist style designs require.

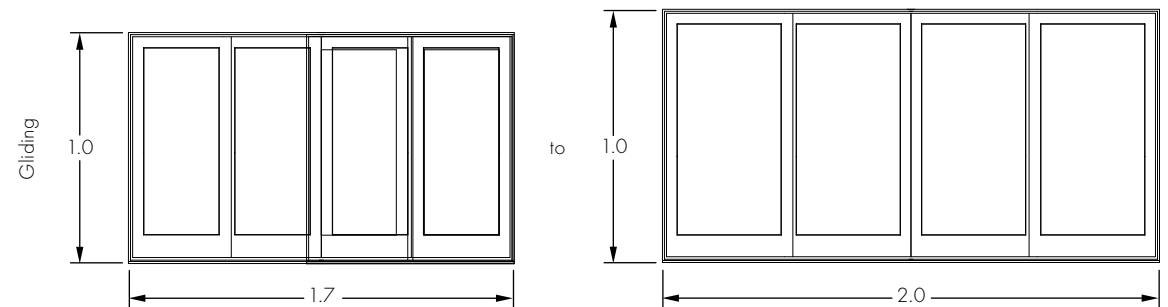

WINDOW HARDWARE

Window hardware in International Modern style homes is eliminated where it can be or minimized. When window hardware is used, it is simple, functional and straightforward with no decorative flourishes.

CASEMENT WINDOW HARDWARE

Casement Handle



White

Push Out Casement
Lock Handle



Satin
Chrome

Push Out Casement
Insect Screen Pull



HARDWARE FINISHES



White

Satin
Chrome

Bright
Chrome

Hardware sold separately.
Printing limitations prevent exact finish replication. Please see your Andersen supplier for actual finish samples.

DOOR HARDWARE

Door hardware is treated much the same as window hardware. Where door hardware is needed, it has no decorative flourishes and is minimized.

FSB® 1076*
Satin Stainless Steel**



Hinged

ANVERS®
Satin Nickel



Hinged

TRIBECA®
White



Hinged

ANVERS®
Satin Nickel



Gliding

HARDWARE FINISHES

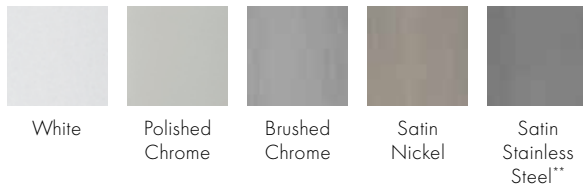

White Polished Chrome Brushed Chrome Satin Nickel Satin Stainless Steel**

Andersen Authenticity

Andersen® doors are available with minimalist hardware styles that are appropriate for all Modernist style home designs. Each hardware choice features a range of finish options to complement whichever Modernist home style variation you choose.

*Other models available. See your Andersen supplier for full line of FSB hardware.

**Satin Stainless Steel is only available on FSB hardware.

Hardware sold separately.

Printing limitations prevent exact finish replication. Please see your Andersen supplier for actual finish samples.

“FSB” is a registered trademark of Franz Schneider Brakel GmbH & Co.

INTERIOR TRIM STYLE ELEMENTS

More often than not, interior trim is eliminated in International Modern style homes. Instead, the wall surface either turns back into the frame or a narrow reveal separates the frame from the adjacent wall surface. When trim is used, it is typically applied as a thin, rectilinear accent line.



Casement Interior



Casement Combination Interior



Gliding Patio Door Interior

INTERNATIONAL MODERN ANDERSEN® PRODUCT INDEX

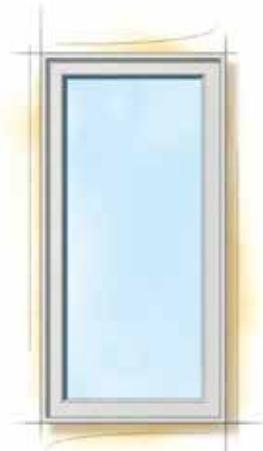

Casement window (exterior)

- Frame exterior: Clear Anodized
 - Sash exterior: Clear Anodized
- Shown on pages 7 and 8.



Casement and auxiliary window combination (exterior)

- Frame exterior: Clear Anodized
 - Sash exterior: Clear Anodized
- Shown on page 7.

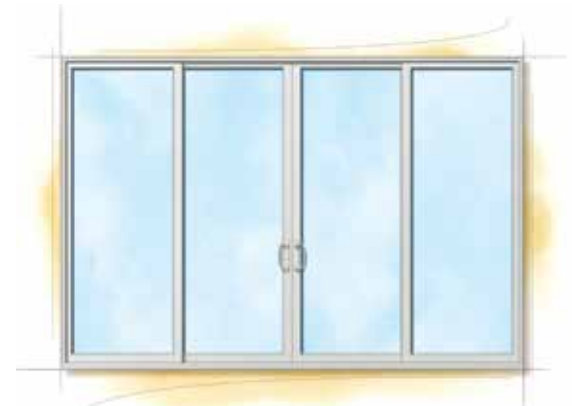

Gliding patio door (exterior)

- Frame exterior: Clear Anodized
 - Stiles & rails exterior: Clear Anodized
 - Standard door hardware: Satin Chrome
- Shown on page 7.



Casement window (interior)

- Frame interior: Cherry with Russet finish
 - Sash interior: Cherry with Russet finish
 - Crank handle: Satin Chrome
- Shown on pages 8 and 14.



Casement and auxiliary window combination (interior)

- Frame interior: Cherry with Russet finish
 - Sash interior: Cherry with Russet finish
 - Crank handle: Satin Chrome
- Shown on page 14.



Gliding patio door (interior)

- Frame exterior: Cherry with Russet finish
 - Stiles & rails interior: Cherry with Russet finish
 - Standard door hardware: Satin Chrome
- Shown on page 14.

THE MIESIAN MODERN HOME



The Miesian Modern style gets its name from Ludwig Mies van der Rohe, who is most commonly referred to simply as Mies. Considered one of the original leaders of the International style, Mies emigrated from Germany and came to the United States in 1938. He became known as the father of the austere, modern glass box house where expressiveness was achieved through the refinement of proportion and detail.

Miesian Modern style homes usually feature a steel structural frame that supports the roof. Since these steel frames relieve the walls of structural responsibility, floor-

to-ceiling windows and doors can be used to make the home become virtually transparent, greatly blurring the line between indoors and outdoors. Additionally, the plane of the floor is raised above the grade, creating a floating effect.

The most famous Mies house is the Farnsworth House in Plano, Illinois. Another well-known example of the Miesian style is the Johnson House, designed by Philip Johnson, in New Canaan, Connecticut.



ESSENTIAL STYLE ELEMENTS

- Floor-to-ceiling windows or glass doors used as transparent barriers between indoors and outdoors
- Windows and doors with narrow frame and sash profiles, making them disappear as much as possible
- Simple rectangular form, usually with a raised floor plane and flat roof plane
- Roof plane supported by structural steel frame, allowing glass to wrap corners

EXTERIOR COLOR PALETTE

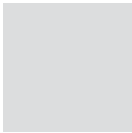

Clear
Anodized



Copper
Anodized

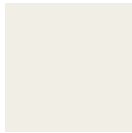

White

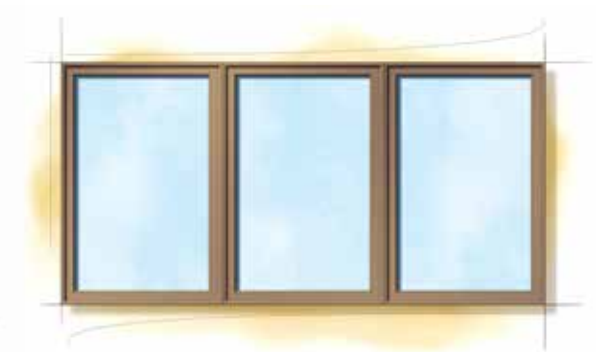

COLORS & FINISHES

Exterior colors in the Miesian Modern style usually emphasize the type of material that's being used. Wood is often stained dark, and metal finishes such as natural aluminum are common. When a painted finish is used, it is most frequently white.

WINDOW/DOOR EXTERIOR

Color Palette



Clear Anodized Copper Anodized

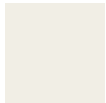

White



Exterior

WINDOW/DOOR INTERIOR

Wood Species



Walnut Mahogany*



Cherry Maple

Stain Colors



Russet Espresso



Mocha Clear Coat

Painted

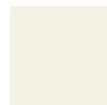

White

Anodized



Clear Anodized



Interior

*Actual wood species is either Sapele or Sipo, both non-endangered species grown in Africa, with color and characteristics similar to Central American mahoganies. Printing limitations prevent exact color duplication. Please see your Andersen supplier for actual color samples.

GROUPINGS

Miesian Modern style homes typically use doors and glass in fixed frames to create glass walls that span from the floor to the ceiling. Often, these glass walls wrap the entire perimeter of the home and are broken only by mullions or the occasional structural column. The doors and glazing are arranged in long bands and sometimes wrap corners when corner columns are not present. The largest possible window and door units are usually used to increase the expanse of uninterrupted glass.

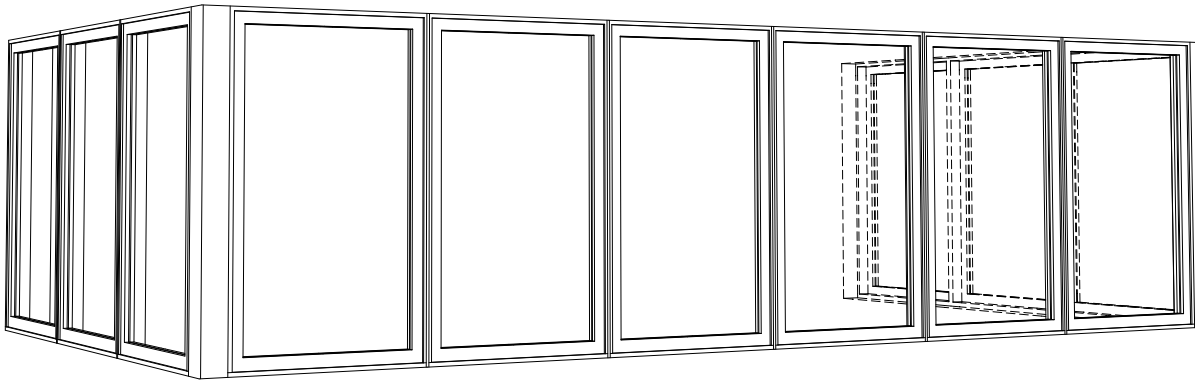

Continuous wraparound windows.

Andersen Authenticity

Andersen gives you the ability to create huge openings and seamless transitions that are integral to Modernist home designs. With virtually limitless options including curved and corner configurations, our products offer stunning ways to help connect the indoors to the outside.

SASH DESIGN

The windows in International Modern style homes try to emphasize the glass area while the frames and sash are made to disappear as much as possible.

For this reason, stationary windows are quite common. Often, the sash is eliminated entirely and the glass is placed directly into the frame, rather than into a sash that is installed into a frame.

Operable units simply have the sash added, making it easy to differentiate between operating and stationary windows.

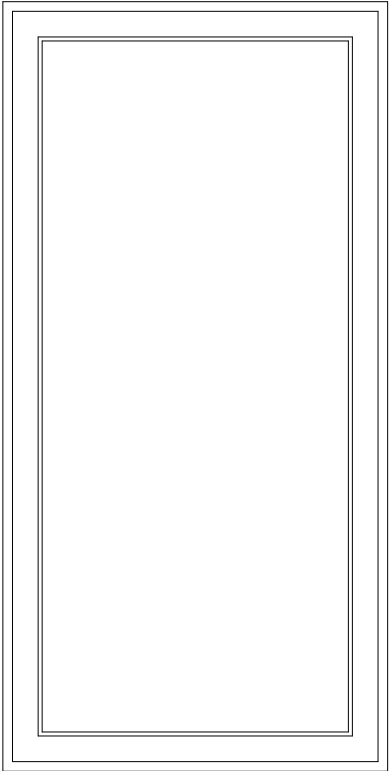
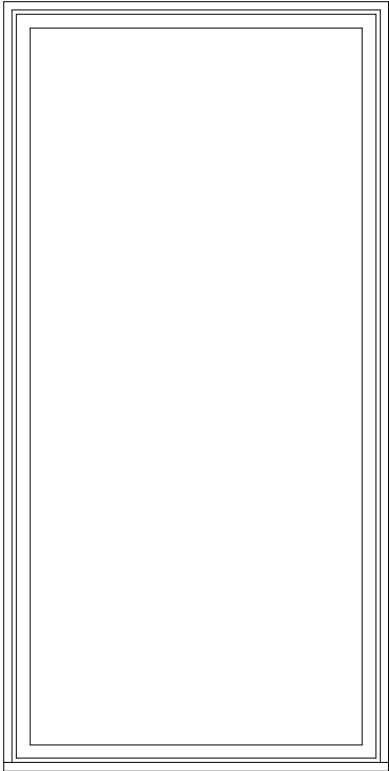
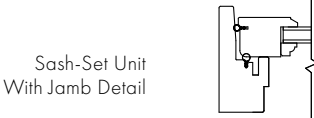
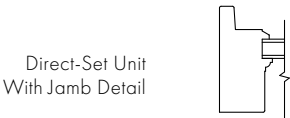

DOOR PROPORTIONS

In purest Miesian Modern style homes, main entrance doors are frequently integrated within the entire glazed wall system, without a distinguishable “door” or entrance appearance that is common in nearly all other styles. Therefore, it becomes less meaningful to focus on the proportions of the door itself as opposed to the overall size of glazing and the ratio of glazing to the solid wall.

That said, typical Miesian Modern style exterior walls are 80 to 100 percent glazed.

Contemporary examples of Miesian Modern style are likely to have a more clearly defined main entrance element and/or entrance door itself. It may be a door joined with a window grouping or even within an occasional small segment of solid wall in an otherwise primarily transparent house exterior. While standard door proportions can be found, use of taller doors is more common.

Typical proportion ratios – Main doors

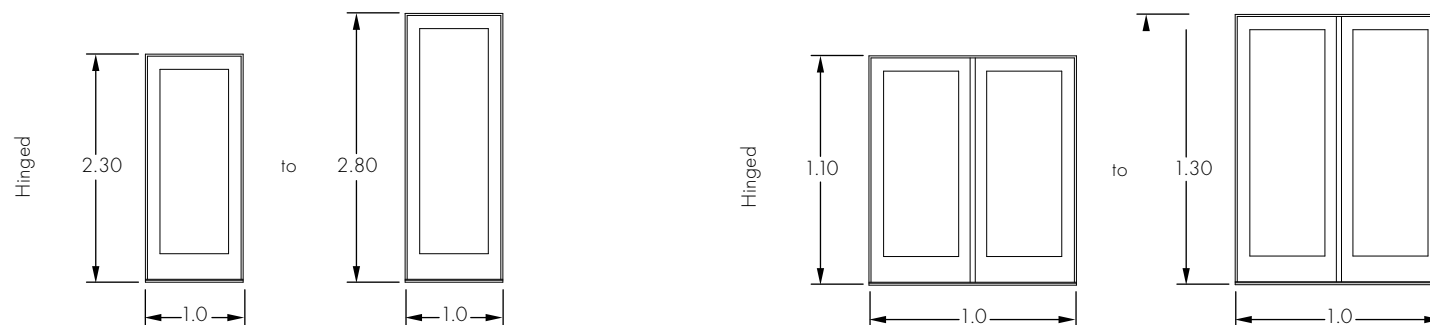

Typical proportion ratios – Auxiliary doors

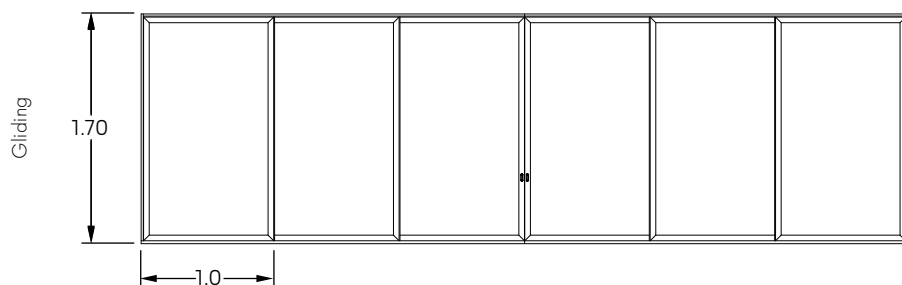

Andersen Authenticity



To help make your vision a reality, Andersen® doors are available in custom sizes and may be ordered to the exact specifications your Modernist style designs require.

WINDOW HARDWARE

In Miesian Modern style homes, superfluous detail is omitted. As a result, window hardware is eliminated wherever possible. Additionally, since stationary windows extending from the floor to the ceiling are a hallmark of this style, there often is no window hardware in Miesian Modern style homes.

When window hardware is necessary or simply desired, it is simple, functional and straightforward and has no decorative flourishes.

CASEMENT WINDOW HARDWARE

Casement Handle



White

Push Out Casement Lock Handle



Satin Chrome

Push Out Casement Insect Screen Pull



HARDWARE FINISHES



White

Satin Chrome

Bright Chrome

Oil Rubbed Bronze

Hardware sold separately.
Oil rubbed bronze is a "living" finish that will change with time and use.
Printing limitations prevent exact finish replication. Please see your Andersen supplier for actual finish samples.

DOOR HARDWARE

Door hardware in Miesian Modern style homes is treated the same as window hardware. It should be minimized, it should have no decorative flourishes and it should be made to disappear whenever possible.



HARDWARE FINISHES

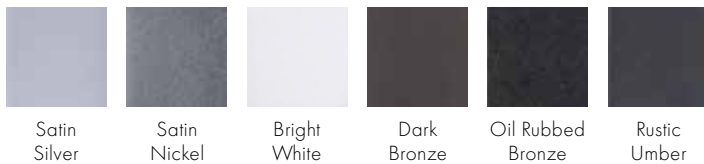

Andersen Authenticity

Andersen® doors are available with minimalist hardware styles that are appropriate for all Modernist style home designs. Each hardware choice features a range of finish options to complement whichever Modernist home style variation you choose.

Hardware sold separately.

Oil rubbed bronze is a "living" finish that will change with time and use.

Printing limitations prevent exact finish replication. Please see your Andersen supplier for actual finish samples.

INTERIOR TRIM STYLE ELEMENTS

More often than not, interior trim is eliminated in Miesian Modern style homes. Instead, the wall surface either turns back into the frame or a narrow reveal separates the frame from the adjacent wall surface. When trim is used, it is typically applied as a thin, rectilinear accent line.



Casement Interior

Casement Combination Interior

Liftslide Door Interior

MIESIAN MODERN ANDERSEN® PRODUCT INDEX



Casement window (exterior)

- Frame exterior: Copper Anodized
- Sash exterior: Copper Anodized

Shown on pages 17 and 18.



Casement window combination (exterior)

- Frame exterior: Copper Anodized
- Sash exterior: Copper Anodized

Shown on page 17.



Liftslide door (exterior)

- Frame exterior: Copper Anodized
- Stiles & rails exterior: Copper Anodized
- Flush handle: Oil Rubbed Bronze

Shown on page 17.



Casement window (interior)

- Frame interior: Mahogany* with Russet finish
- Sash interior: Mahogany* with Russet finish
- Standard crank handle: Oil Rubbed Bronze

Shown on pages 18 and 24.



Casement window combination (interior)

- Frame interior: Mahogany* with Russet finish
- Sash interior: Mahogany* with Russet finish
- Standard crank handle: Oil Rubbed Bronze

Shown on page 24.



Liftslide door (interior)

- Frame interior: Mahogany* with Mahogany finish
- Stiles & rails interior: Mahogany* with Russet finish
- Standard handle: Oil Rubbed Bronze

Shown on page 24.

*Actual wood species is either Sapele or Sipo, both non-endangered species grown in Africa, with color and characteristics similar to Central American mahoganies.

THE INDUSTRIAL MODERN HOME



In the hands of different designers, a recognized architectural style may evolve in various directions. The Industrial Modern style home is an ideal example. It's based on the International Modern style, but includes the use of more varied materials to achieve its form.

As a result, interiors in the Industrial Modern style are less stark and pristine than pure International Modern architecture. In its earliest form, the Industrial Modern style

incorporated elements like those found in factories, such as glass block, pipe railings and metal spiral staircases. Today, however, corrugated metal siding, cast concrete and concrete block are also frequently found in many Industrial Modern style home designs.



ESSENTIAL STYLE ELEMENTS

- Functional arrangement of factory-like parts, including windows
- Flat roof
- Multiple window units arranged in rectangular or irregular groupings that benefit interior functions or features
- Simple forms arranged asymmetrically

EXTERIOR COLOR PALETTE



COLORS & FINISHES

Painted exterior finishes are most common in the Industrial Modern style. The color range is quite varied and includes dark colors. For interiors, maple with a clear coat finish is customary. However, other wood species and stains, or painted wood, may also be used.

WINDOW/DOOR EXTERIOR

Color Palette



Exterior

WINDOW/DOOR INTERIOR

Wood Species

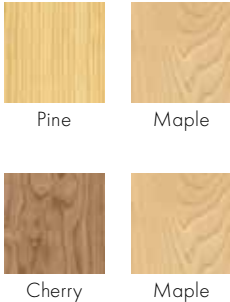

Stain Colors

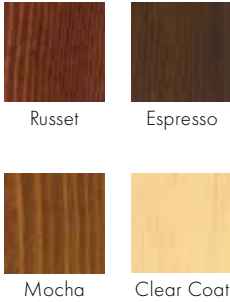

Painted

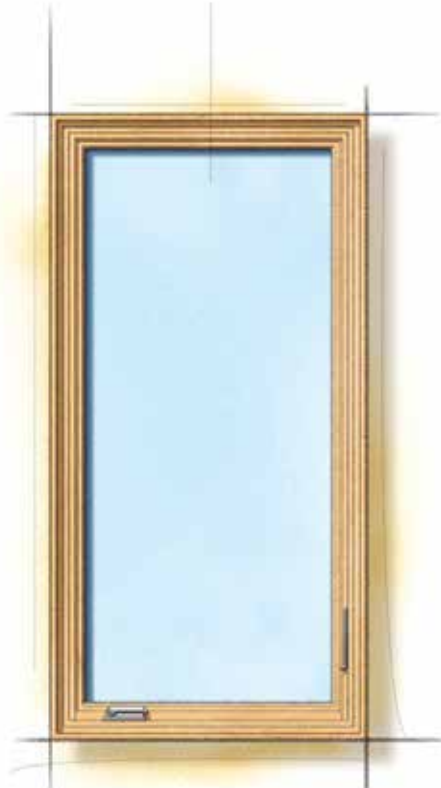

Interior

Printing limitations prevent exact color duplication. Please see your Andersen supplier for actual color samples.

WINDOW GROUPINGS

Window groupings in the Industrial Modern style range from simple rectangles to more complex shapes that reflect either interior function or interior features such as a fireplace. Additional shapes such as trapezoidal or triangular are also used, particularly when the home has a pitched roof. Windows are usually mullioned directly with no additional spacers. Occasionally, extra spacing is given to allow room for exterior flat trim when it's used either as a decorative element that wraps the entire structure or as a way of differentiating one part of the home from another.

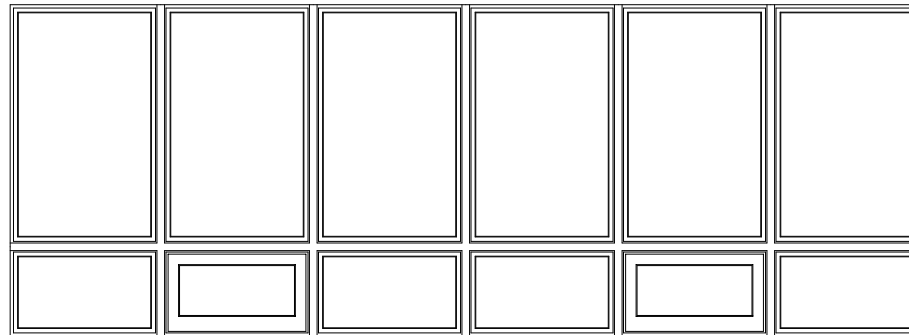

Large rectangular arrangement of fixed windows without sash and two operable windows with sash.

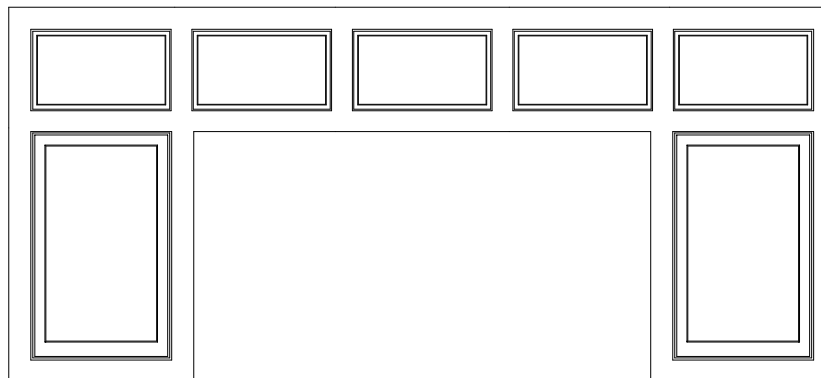

Irregular arrangement of fixed windows without sash and operable windows with sash.

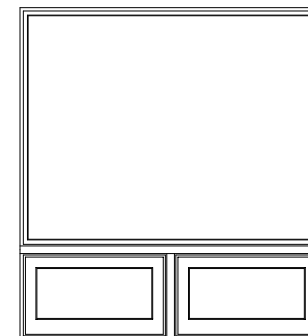

Large fixed window for views to exterior without sash mullioned over operable awning units with sash.

SASH DESIGN

In the Industrial Modern style, a mixture of stationary windows glazed in frames and operating windows glazed in sash is most acceptable, as it places the emphasis on each window's function. If a more consistent look is desired, stationary windows may also include the sash.

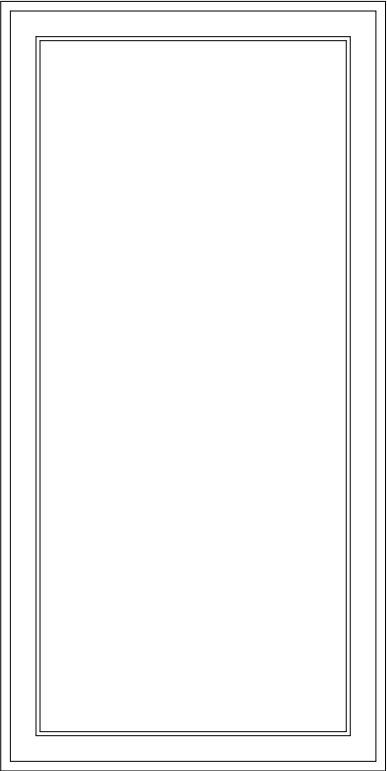
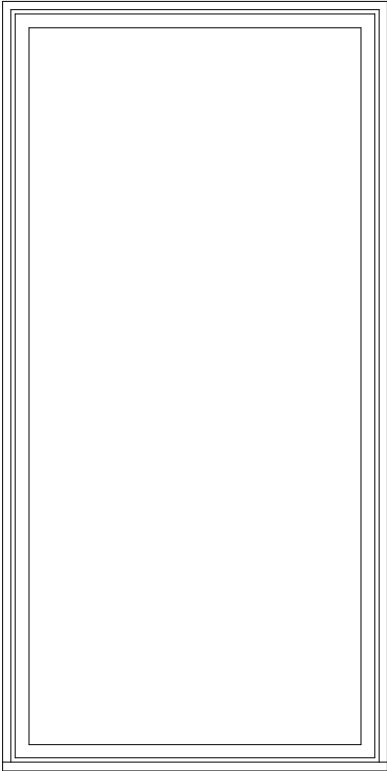
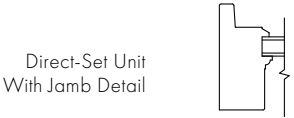

DOOR PROPORTIONS

Main entrance doors in Industrial Modern style homes are frequently single doors. While standard proportions can be found, taller doors are more common.

Auxiliary doors are used at utility entrances and locations such as terraces and patios. Auxiliary doors that are not on a prominent face of the house are usually single doors of a standard size, whereas auxiliary doors leading to a terrace or patio would commonly be multiple doors in one unit. In these instances, the proportion of the entire door unit is both a function of the individual door size and the number of doors within that unit, as is illustrated here.

Typical proportion ratios – Main doors

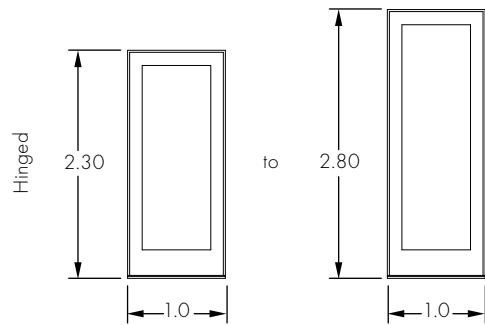

Typical proportion ratios – Auxiliary doors

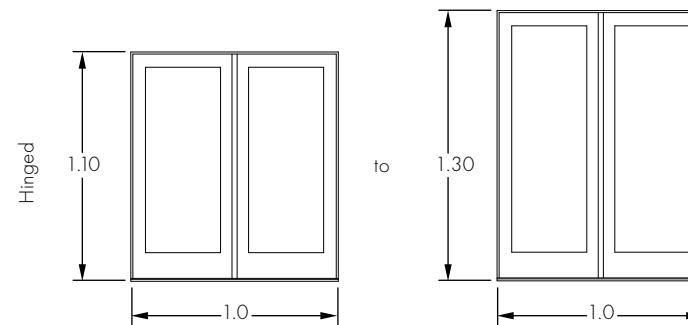

Andersen Authenticity



To help make your vision a reality, Andersen® doors are available in custom sizes and may be ordered to the exact specifications your Modernist style designs require.

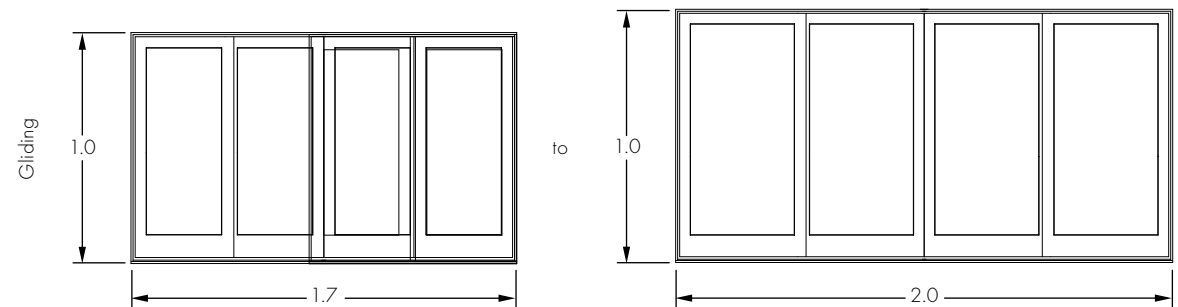

WINDOW HARDWARE

Industrial Modern style window hardware is simple with an emphasis on function. Straightforward hardware that lacks flourishes, or even industrial-looking hardware, would be at home in this style.

CASEMENT WINDOW HARDWARE

Casement Contemporary Folding



Satin Nickel

HARDWARE FINISHES



White

Satin
Nickel

DOOR HARDWARE

Door hardware is treated much the same as window hardware. Minimal hardware is appropriate, although straightforward pieces that are slightly more substantial may also be used.



HARDWARE FINISHES



Andersen Authenticity

Andersen® doors are available with minimalist hardware styles that are appropriate for all Modernist style home designs. Each hardware choice features a range of finish options to complement whichever Modernist home style variation you choose.

Hardware sold separately.
Printing limitations prevent exact finish replication. Please see your Andersen supplier for actual finish samples.

INTERIOR TRIM STYLE ELEMENTS

More often than not, interior trim is eliminated in Industrial Modern style homes. Instead, the wall surface either turns back into the frame or a narrow reveal separates the frame from the adjacent wall surface. When trim is used, it is typically applied as a thin, rectilinear accent line.



INDUSTRIAL MODERN ANDERSEN® PRODUCT INDEX



Casement window (exterior)

- Frame exterior: Black
- Sash exterior: Black

Shown on pages 27 and 28.



Direct-set rectangular window combination (exterior)

- Frame exterior: Black
- Sash exterior: Black

Shown on page 27.



Frenchwood® gliding patio door (exterior)

- Stiles & rails exterior: Black
- Anvers® door hardware: Satin Nickel

Shown on page 27.



Casement window (interior)

- Frame interior: Maple with Clear Coat finish
- Sash interior: Maple with Clear Coat finish
- Contemporary casement window folding handle: Satin Nickel

Shown on pages 28 and 34.



Direct-set rectangular window combination (interior)

- Frame interior: Maple with Clear Coat finish
- Sash interior: Maple with Clear Coat finish
- Contemporary casement window folding handle: Satin Nickel

Shown on page 34.



Frenchwood® gliding patio door (interior)

- Frame interior: Maple with Clear Coat finish
- Stiles & rails interior: Maple with Clear Coat finish
- Anvers door hardware: Satin Nickel

Shown on page 34.



"Andersen" and all other marks where denoted are trademarks of Andersen Corporation.
©2020 Andersen Corporation. All rights reserved. 12/20 Part #9103594